

PARAMETRIC DUBLIN

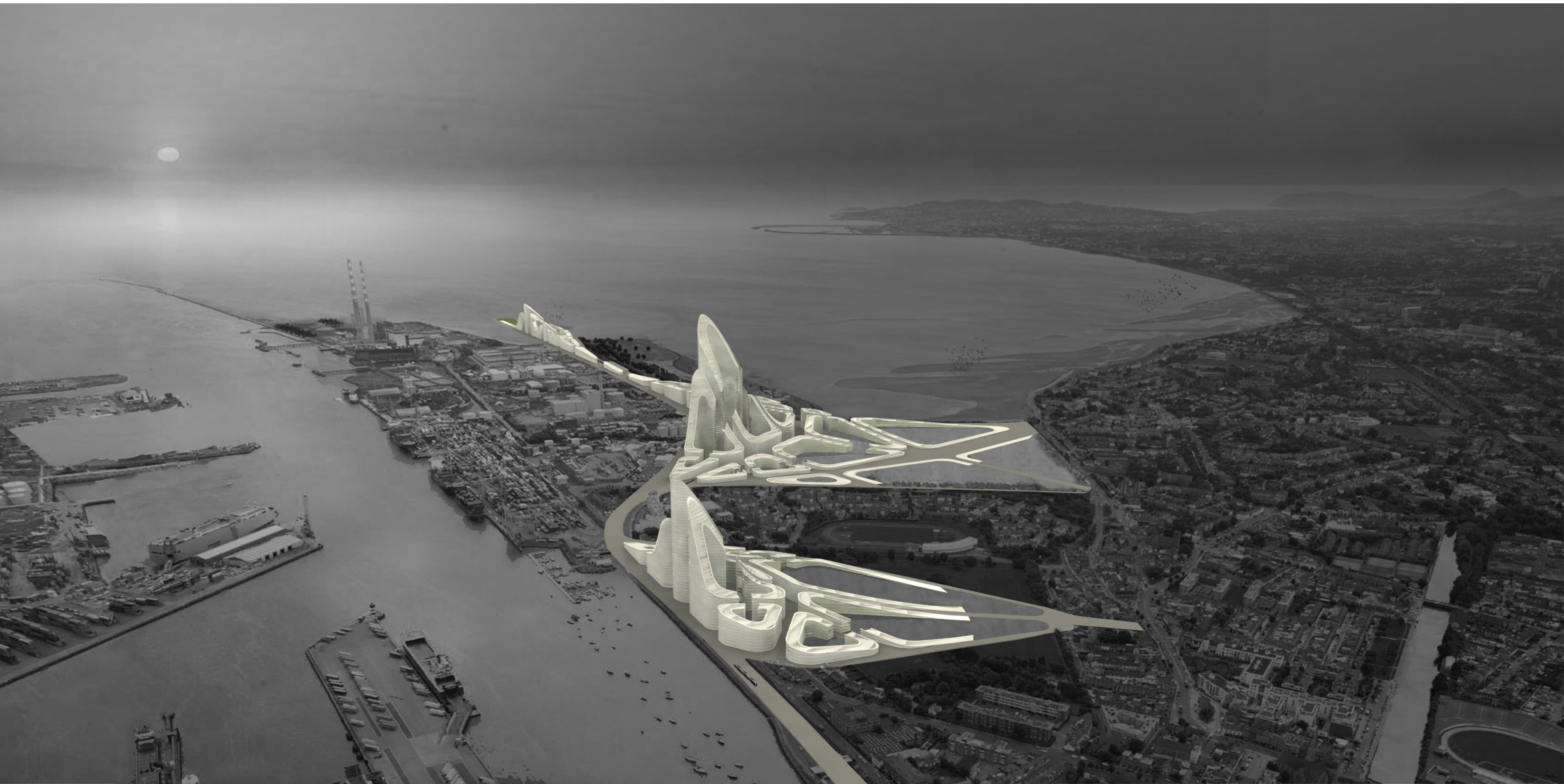

TOOL

GENERATIVE MODELING

GENERATIVE DESIGN IS NOT ABOUT DESIGNING THE BUILDING, IT'S ABOUT DESIGNING THE SYSTEM THAT BUILTS THE BUILDING

WHAT?

For designers who are exploring new shapes using generative algorithms, Grasshopper® is a graphical algorithm editor tightly integrated with Rhino's 3-D modeling tools. Unlike Rhino-Script, Grasshopper requires no knowledge of programming or scripting, but still allows designers to build form generators from the simple to the awe-inspiring.

FROM GRASSHOPPER OFFICIAL BLOG

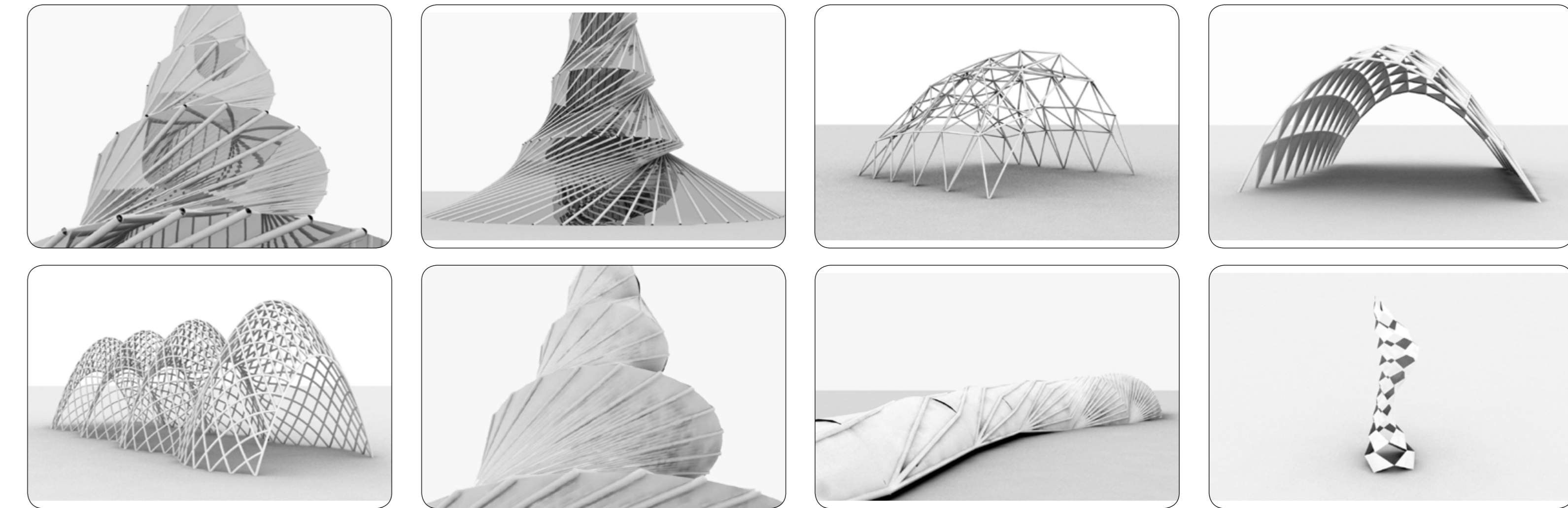

training

WHY?

Rhino4 came with a basic history feature built-in, which is a non-intrusive layer around the workflow that allows for automatic updates of certain modeling steps. The current implementation of **History in Rhino4 is implicit**, that is: it is recorded as you go. This means there is no additional overhead required at model-time which is exactly the sort of thing we would like to see in Rhino: more features, no additional limitations. However, implicit history cannot do some things which are possible with explicitly defined history.

First of all, the history **tree is hidden from the user**. The behaviour of the different history stages cannot be adjusted. For example, there is only one chance to set the properties of a history based Loft. Once the surface exists, **the only way to change the Loft settings is to recreate the surface**. This will break all downstream history records and is thus potentially an extremely expensive limitation. It is also impossible to add or replace curves from a history Loft.

Grasshopper tackles these issues by allowing the user to construct their own "history tree" or better "definition" of the procedure that will be used to construct the object(s). This definition is constructed in a unique visual and interactive way, making it easy to learn and fun even for people with no previous programming experience.

There are of course limitations that come with the process. It is no longer possible to record the history tree transparently, **it has to be specifically constructed by the user**. It is impossible to use available Rhino commands since they do not expose the options and settings they need to run.

However, the advantages speak for themselves:

The tree is exposed, and can thus in whole or in part be re-used throughout different models. The components on the tree are exposed and can thus be replaced or adjusted. **The operations are not tied to geometry** in the model, it is possible to make a tree which only deals with mathematics. **Mathematical and logical relationships can be constructed**. External (to Rhino) sources can be used to retrieve (recuperare) and store data. This makes Grasshopper is a marvelous tool to be explored by anyone who is interested in generative modeling of complex objects or more control over the characteristics of even simple objects.

Grasshopper is a Work-in-Progress. Features and procedures are added/changed often. Much more time will be needed for the feature set to be complete enough for an official 1.0 release, but it is already being used by thousands of people world-wide.

FROM ROBERT MCNEEL

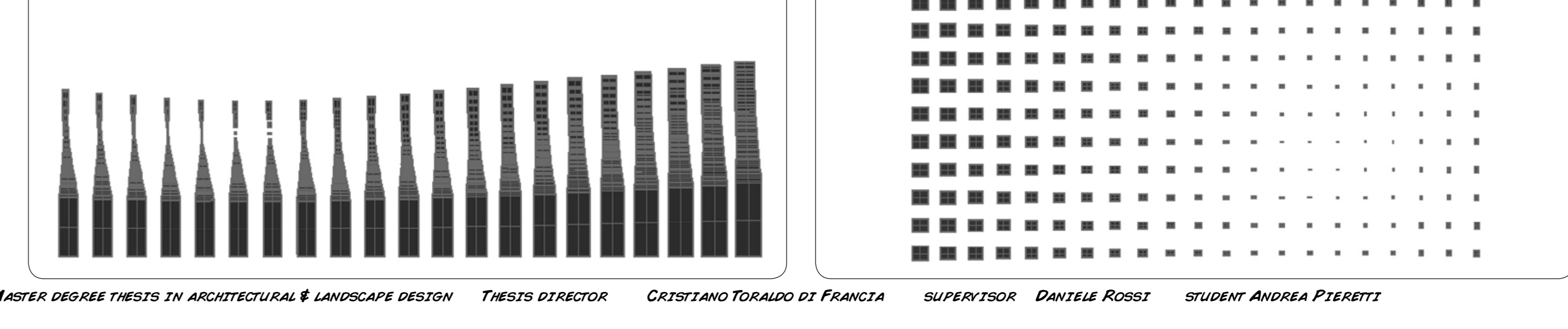
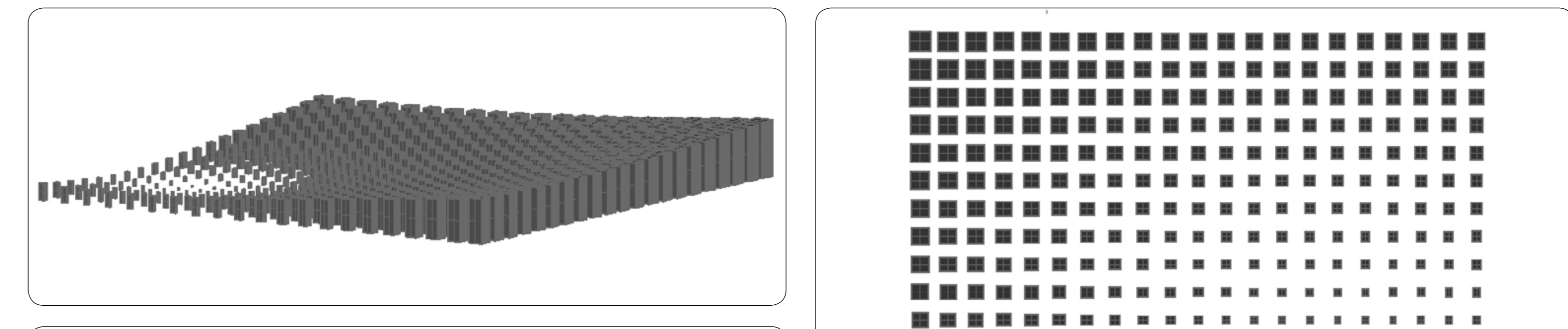
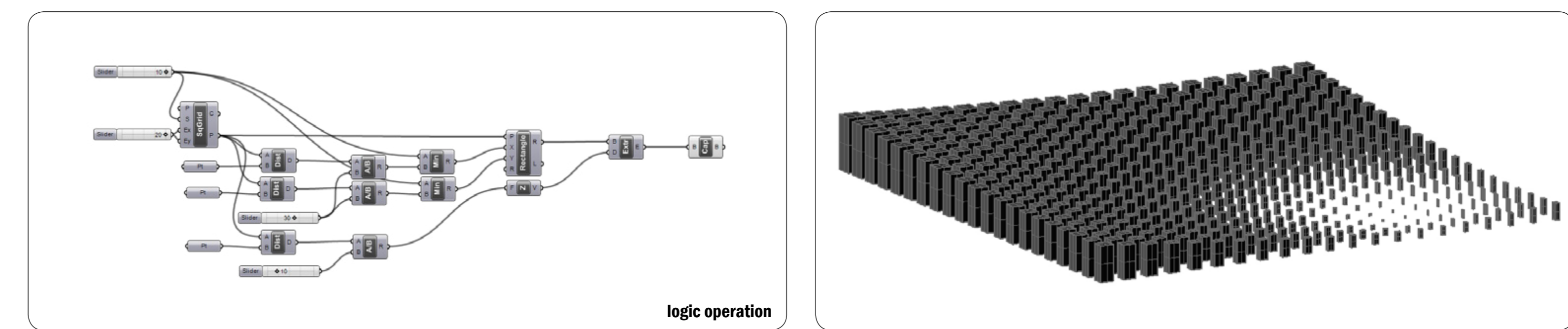
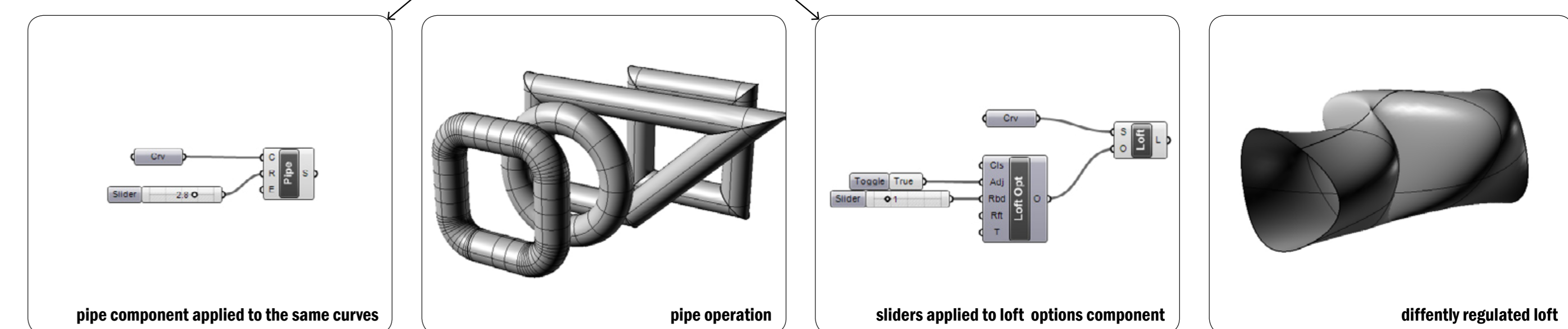
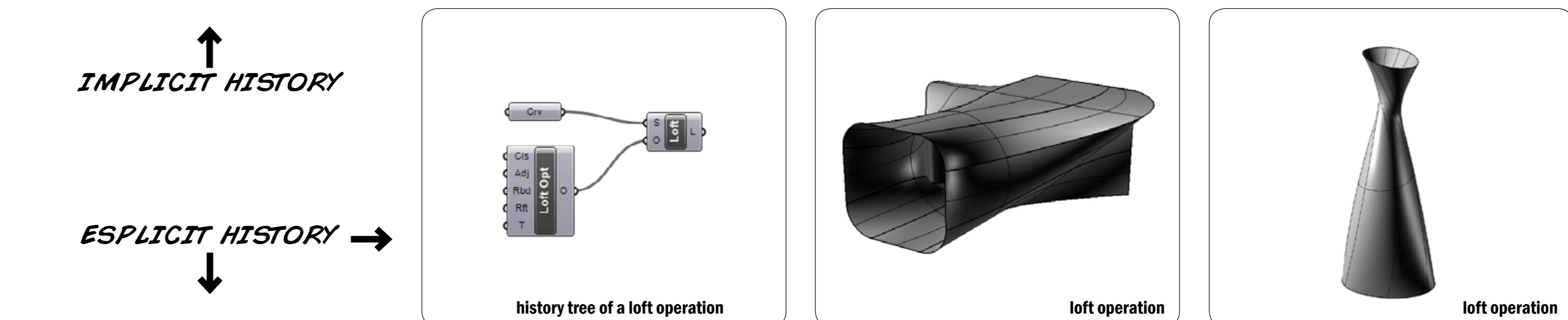
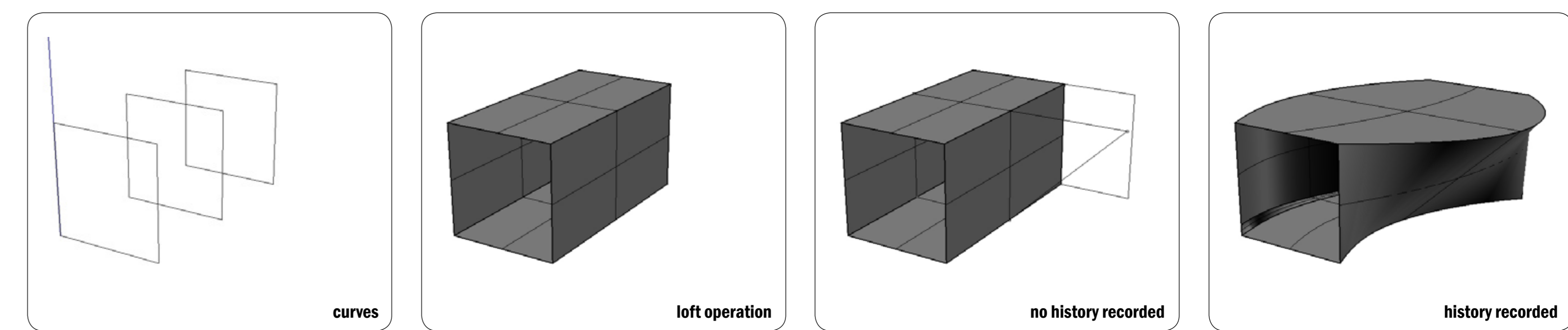

ALGORITHM

LOTS:
BUILDINGS
BOUNDARIES

CURVES:
5 RHINO
SPLINES

EXTRUSIONS

EQUATION WHICH AFFECTS THE EXTRUSION

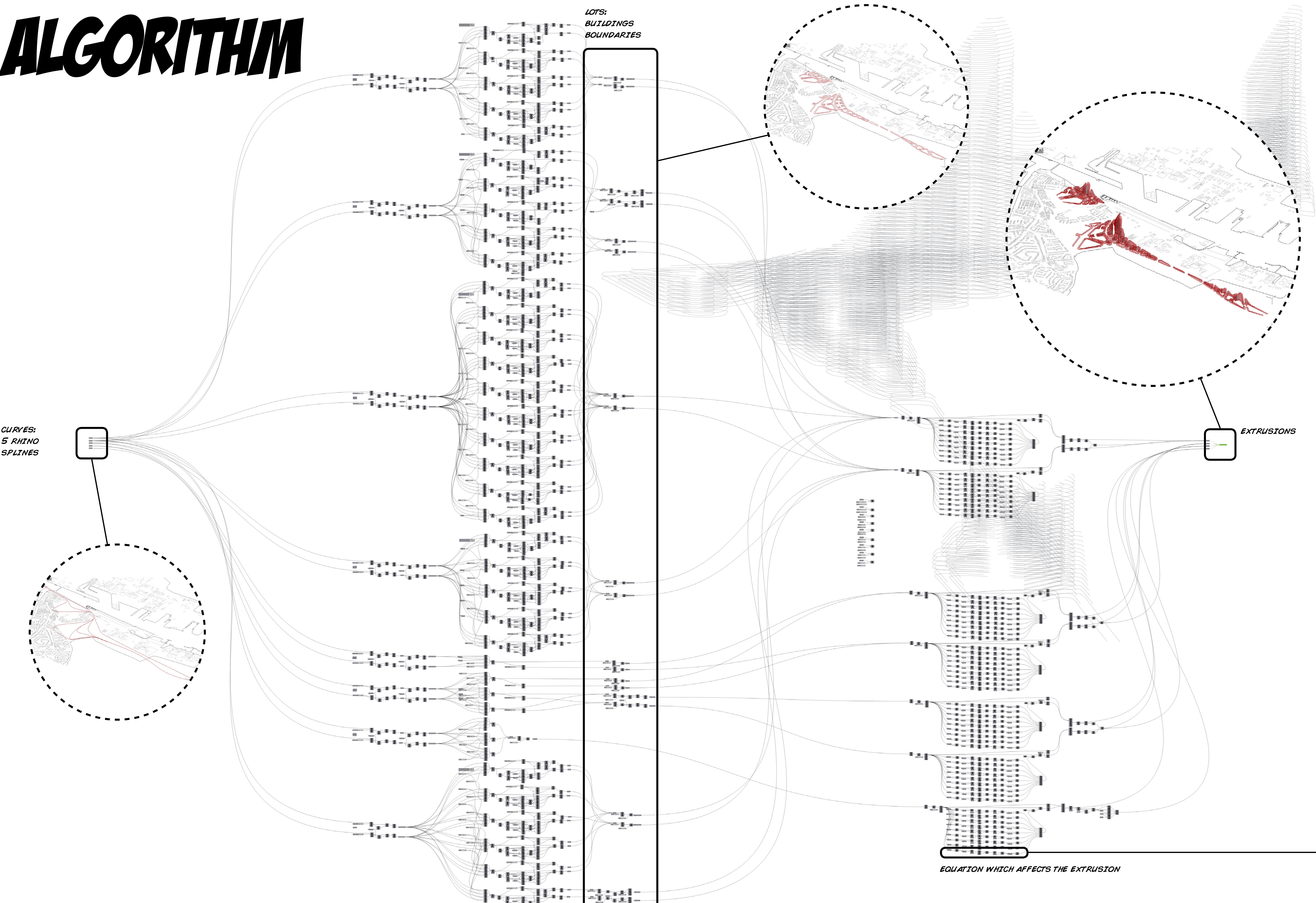

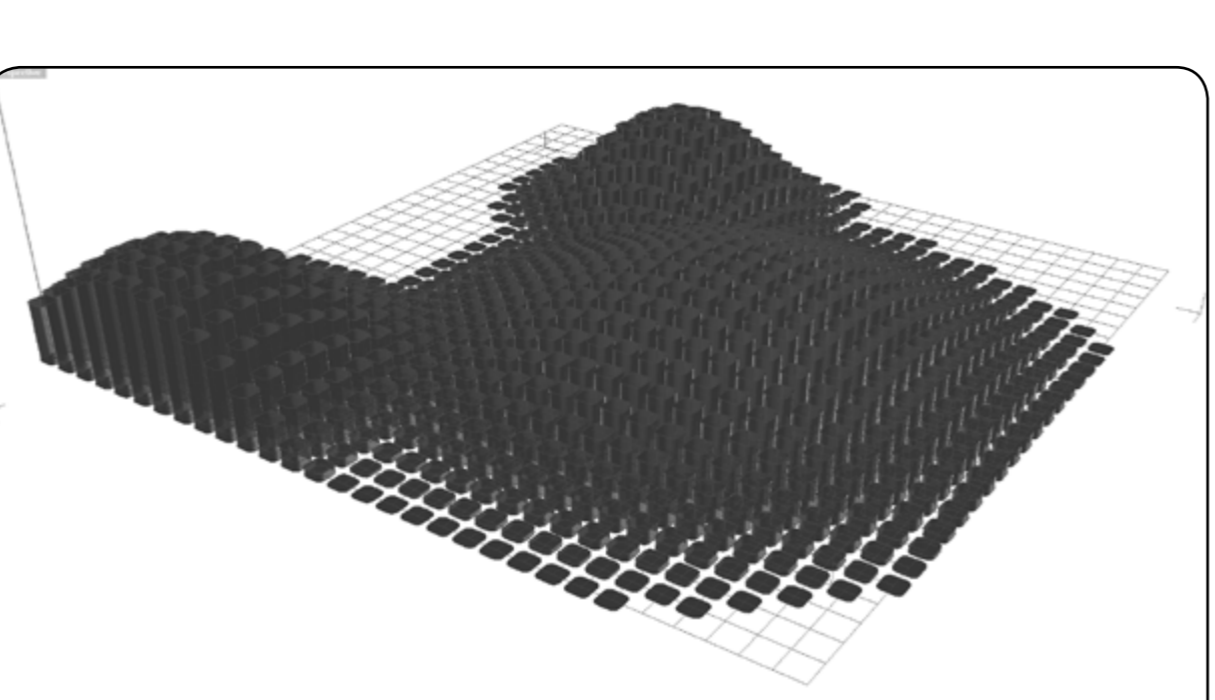
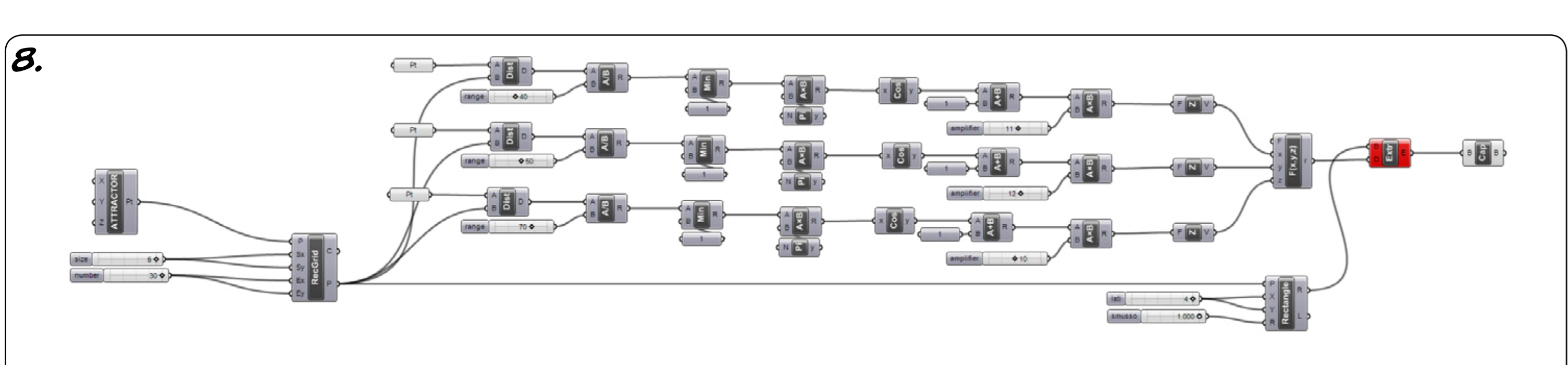
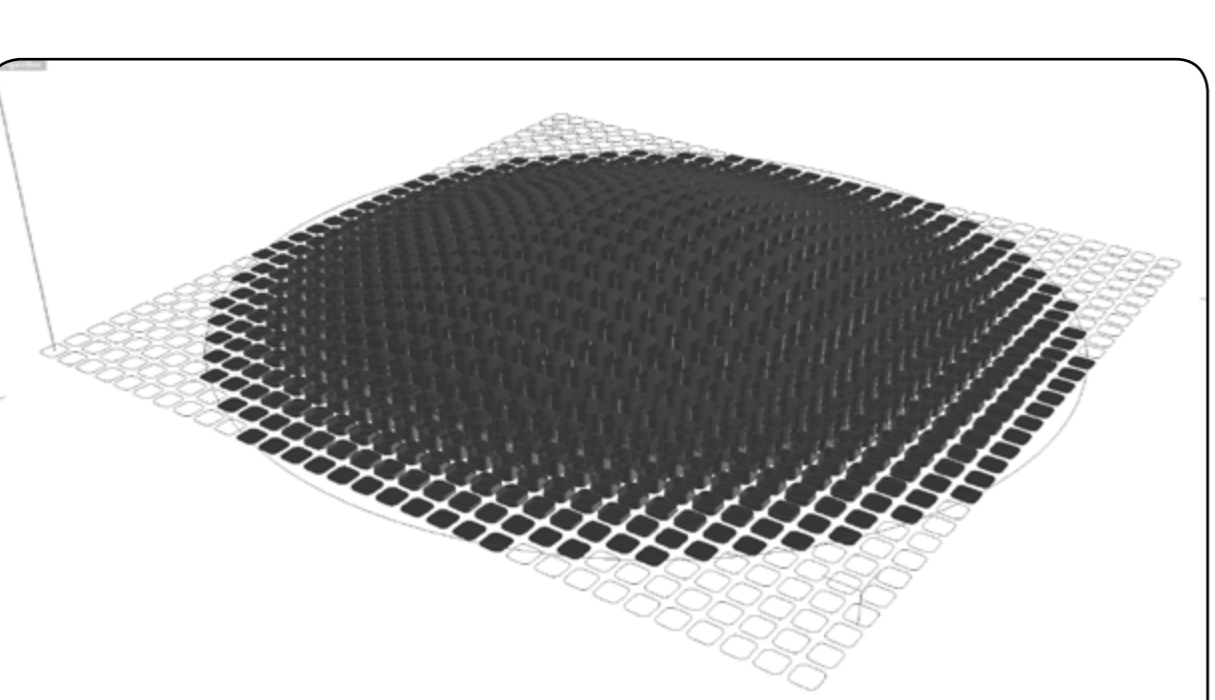
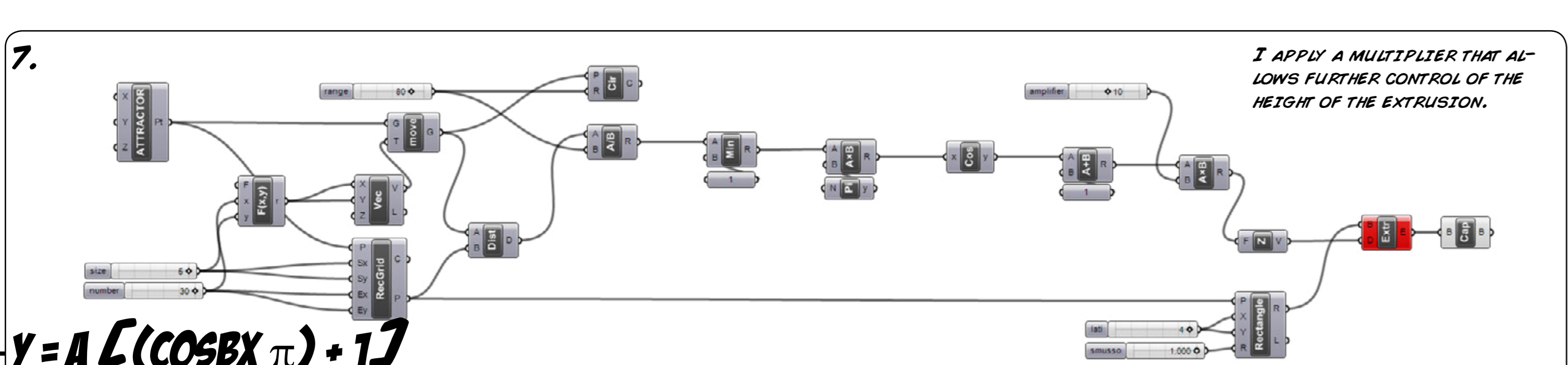
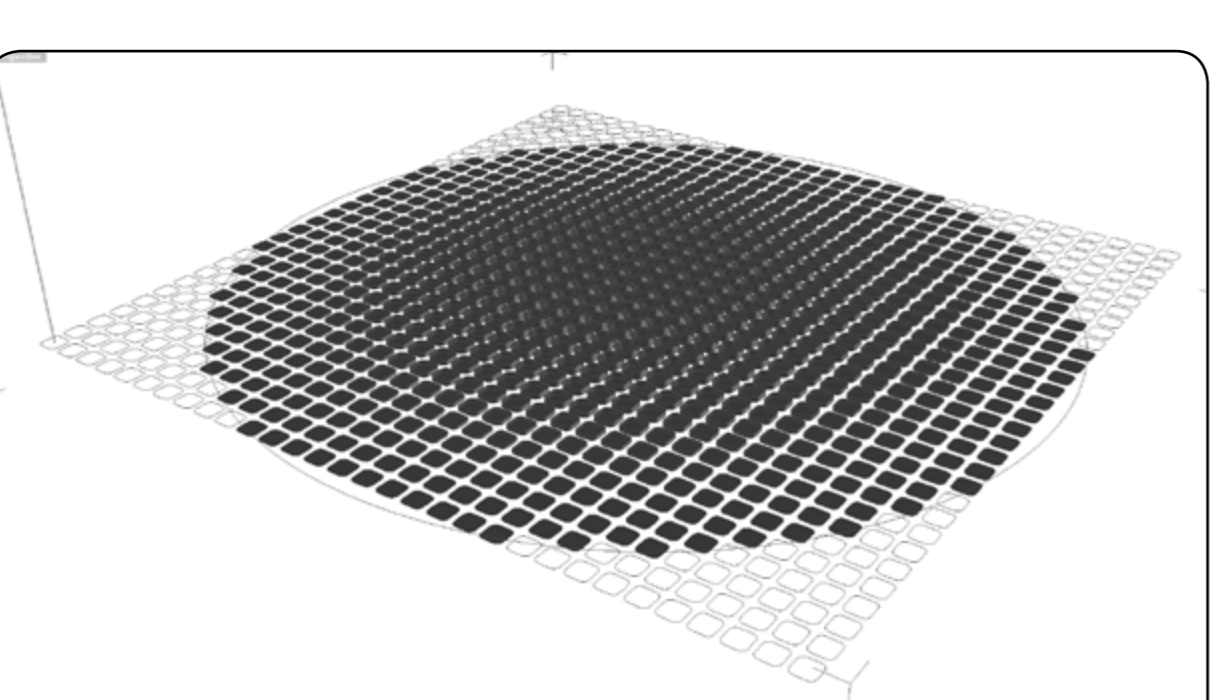
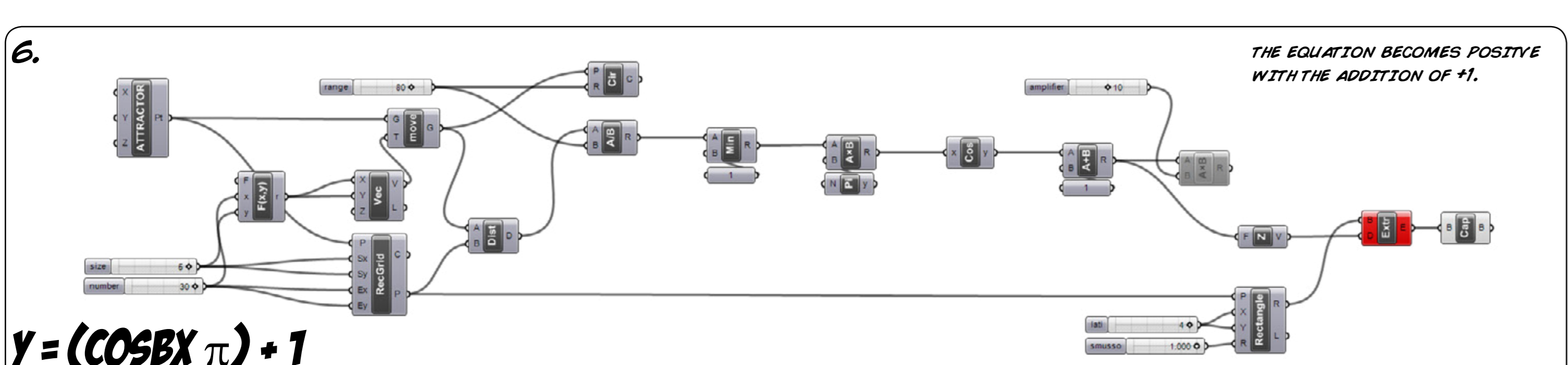
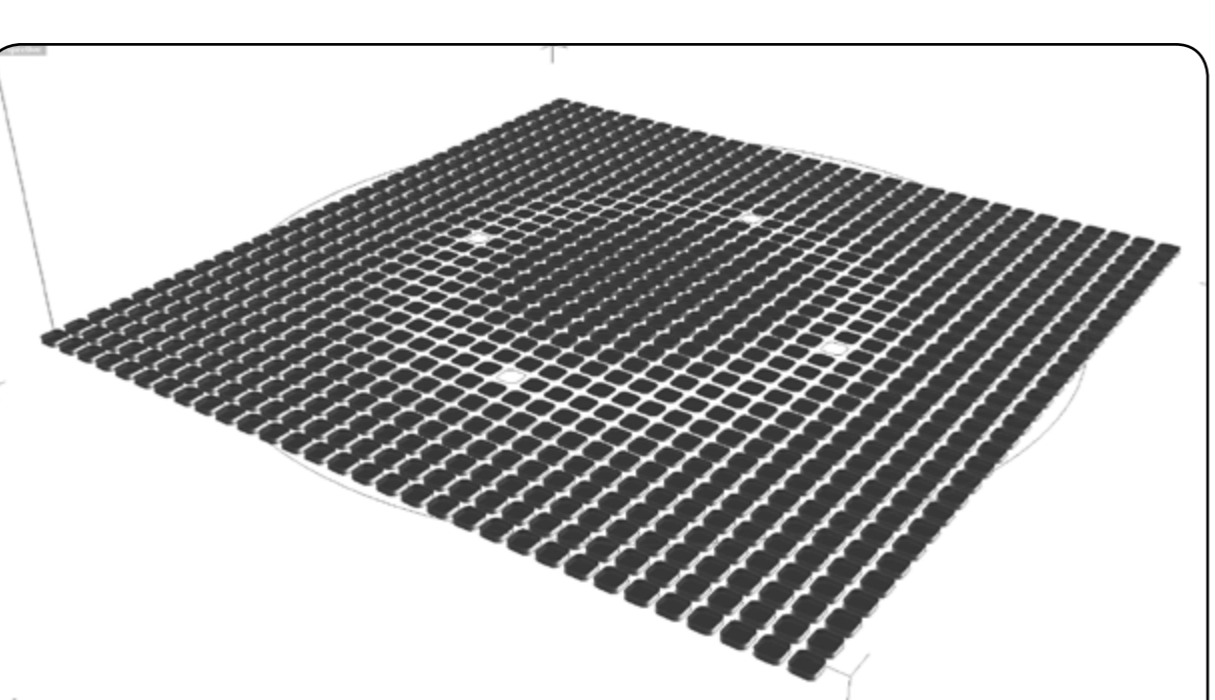
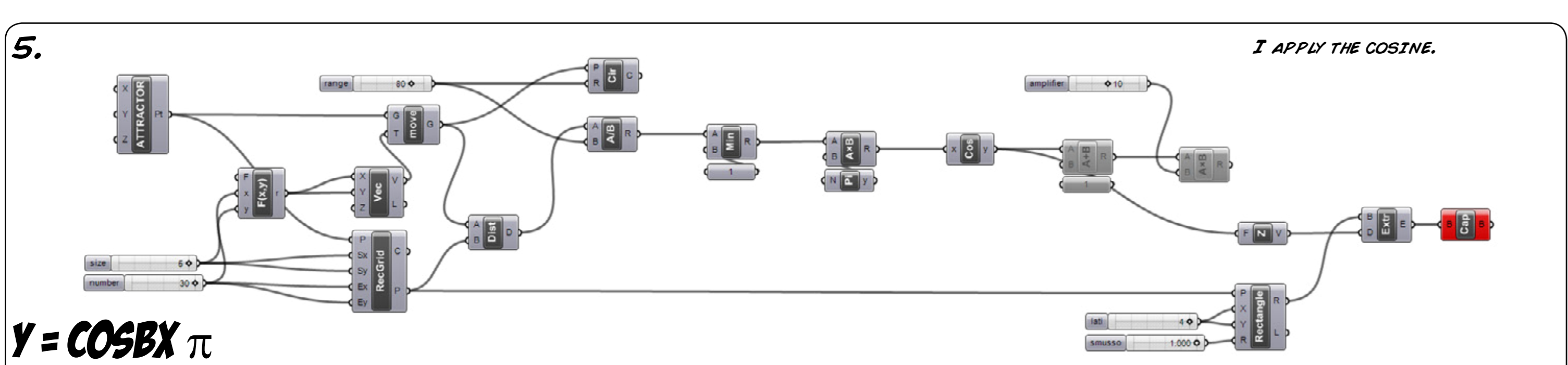
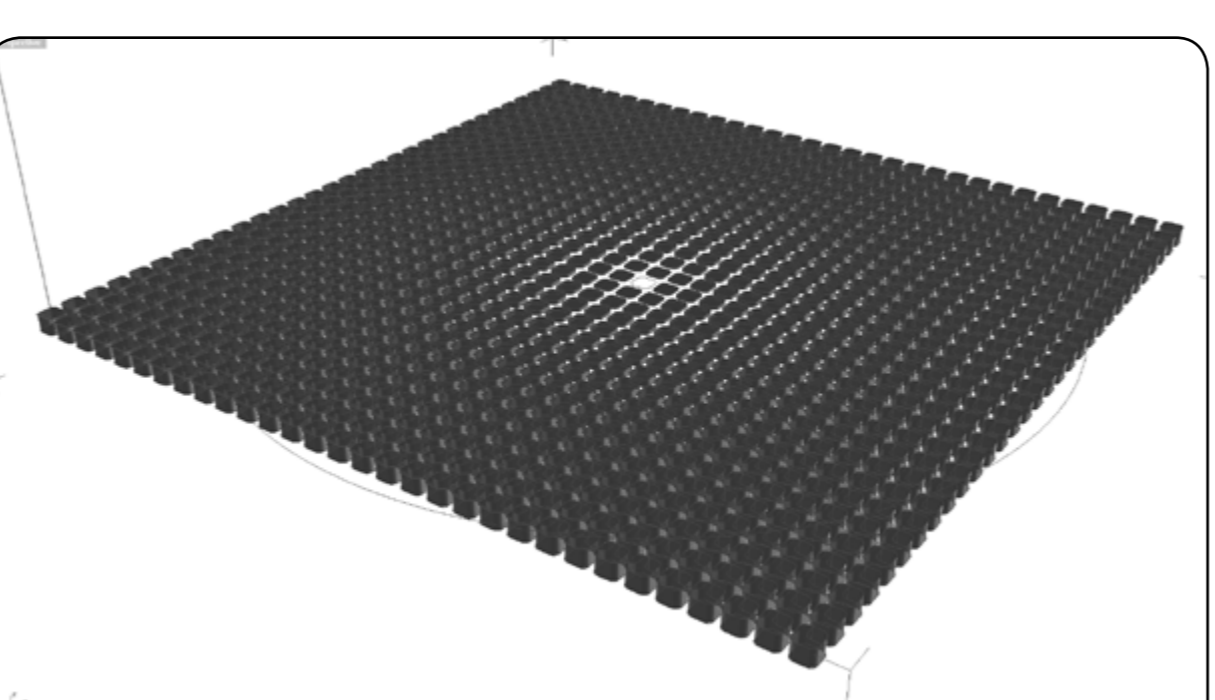
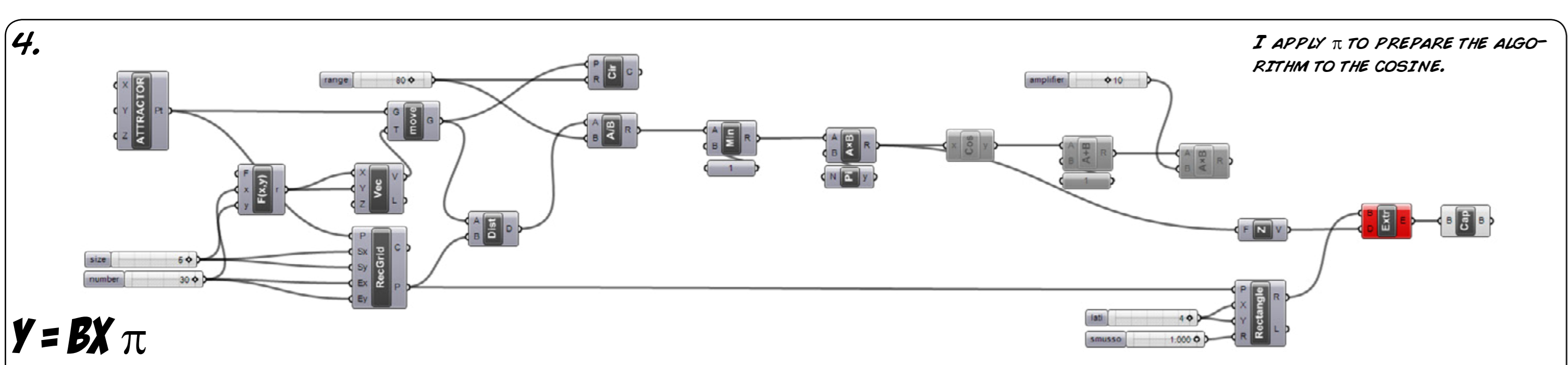
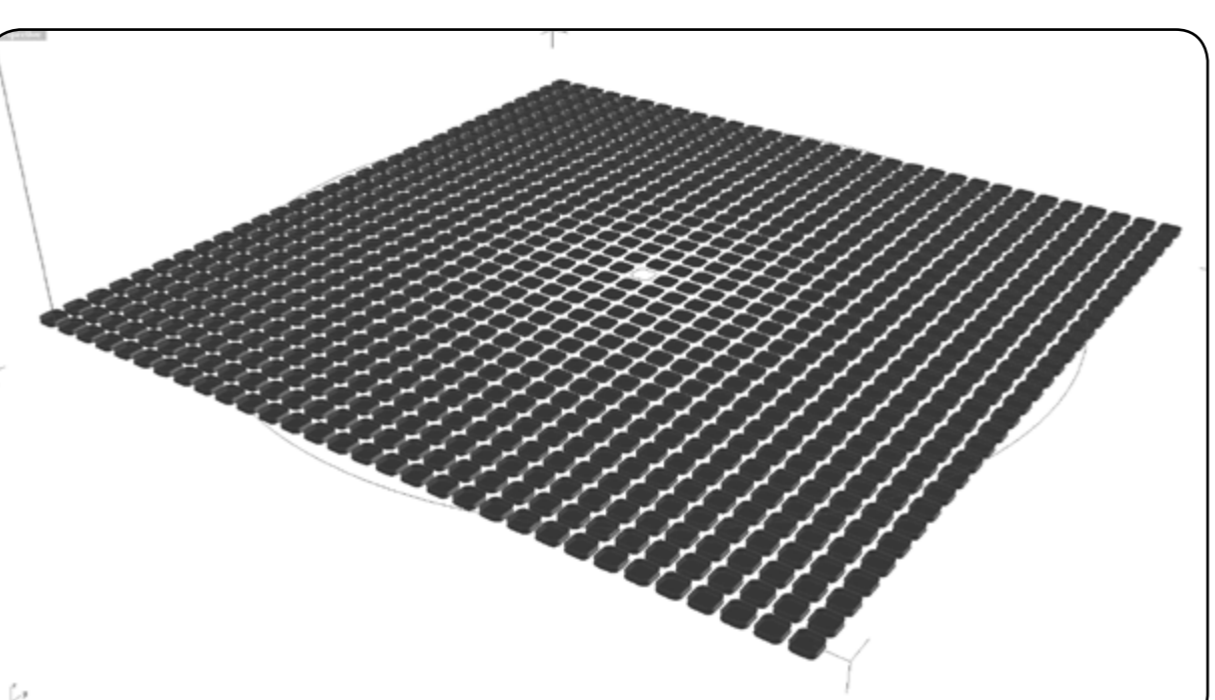
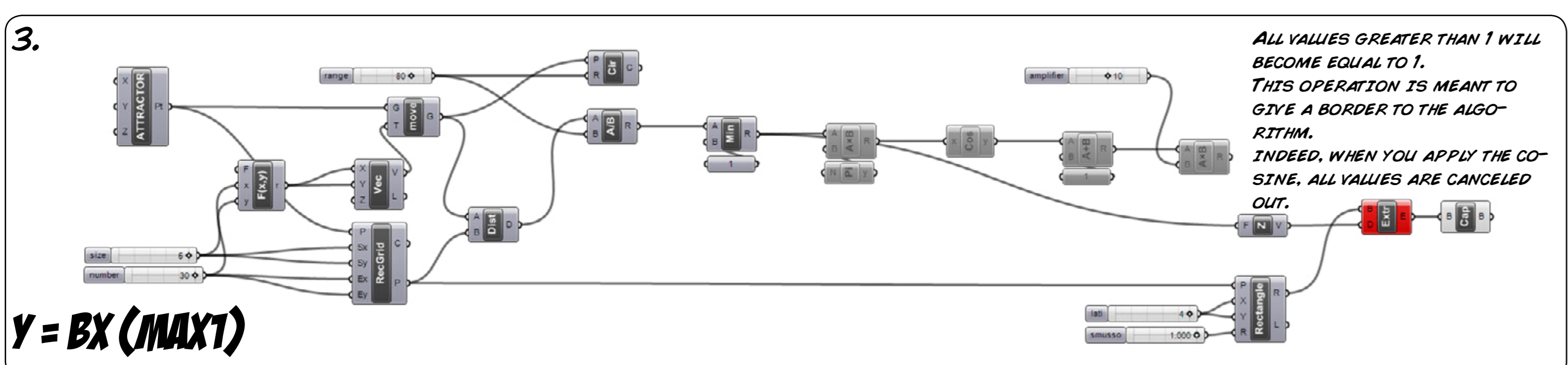
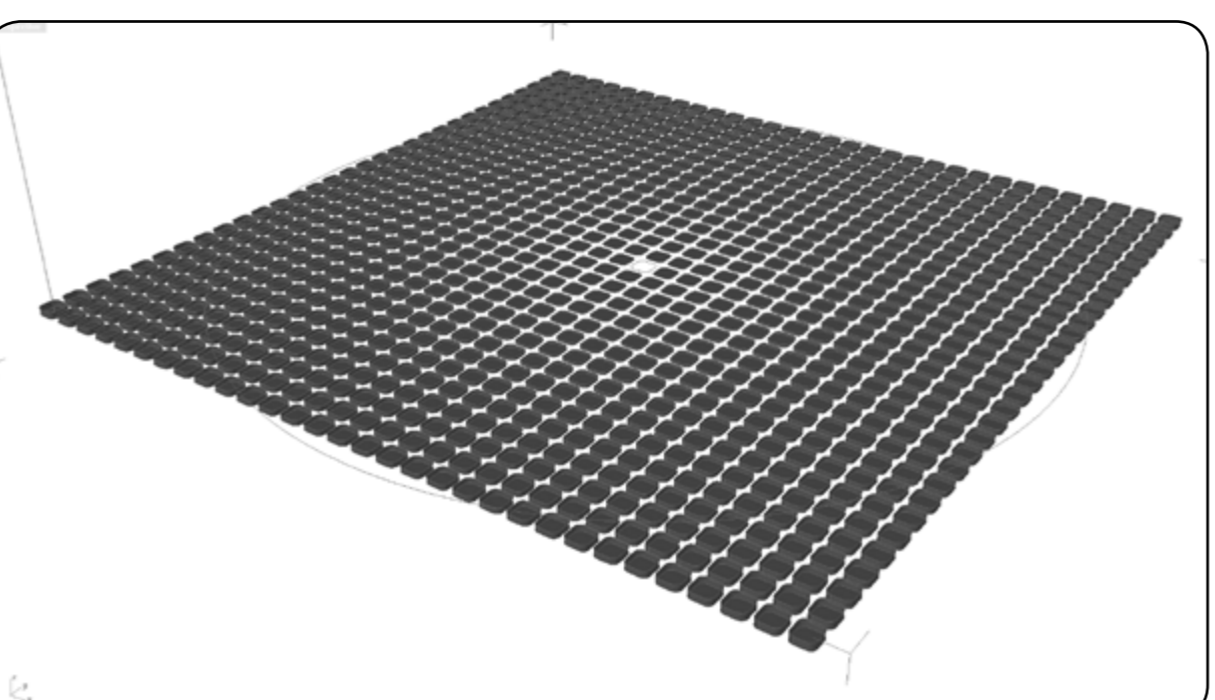
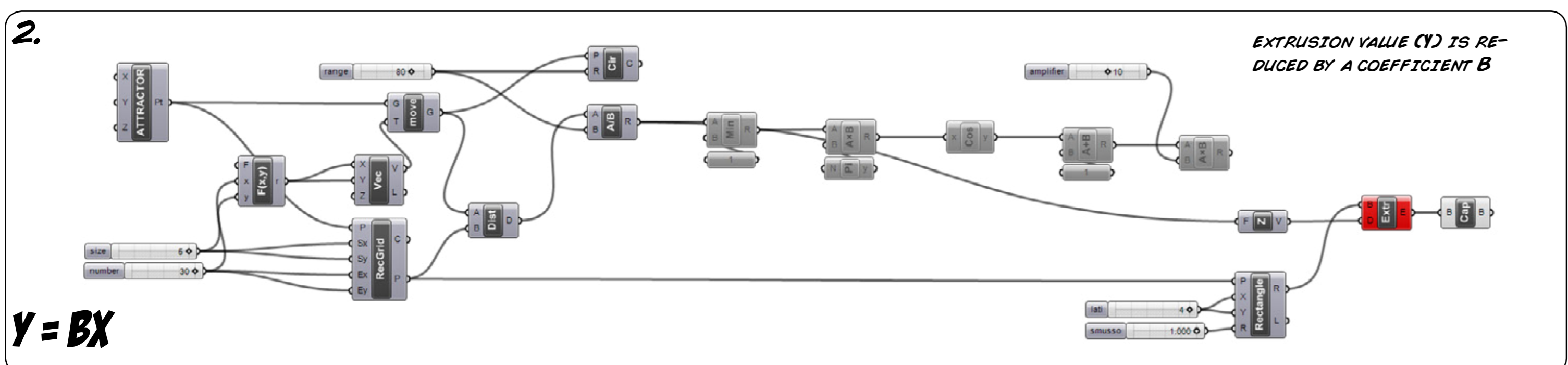
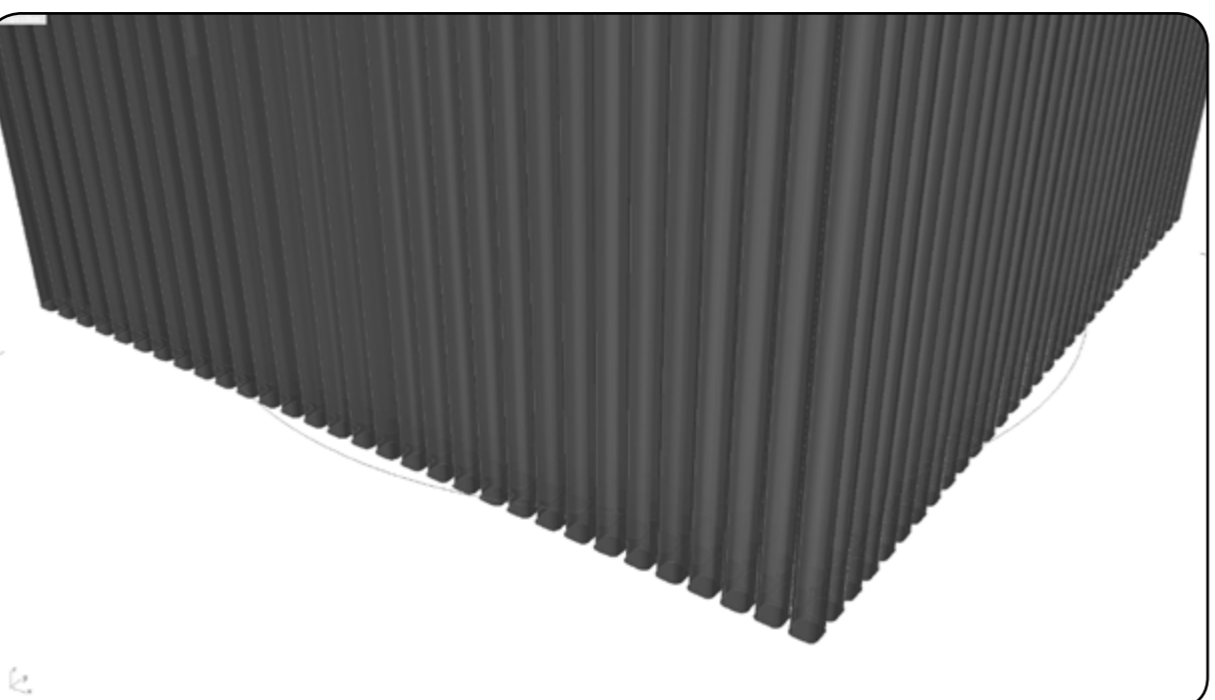
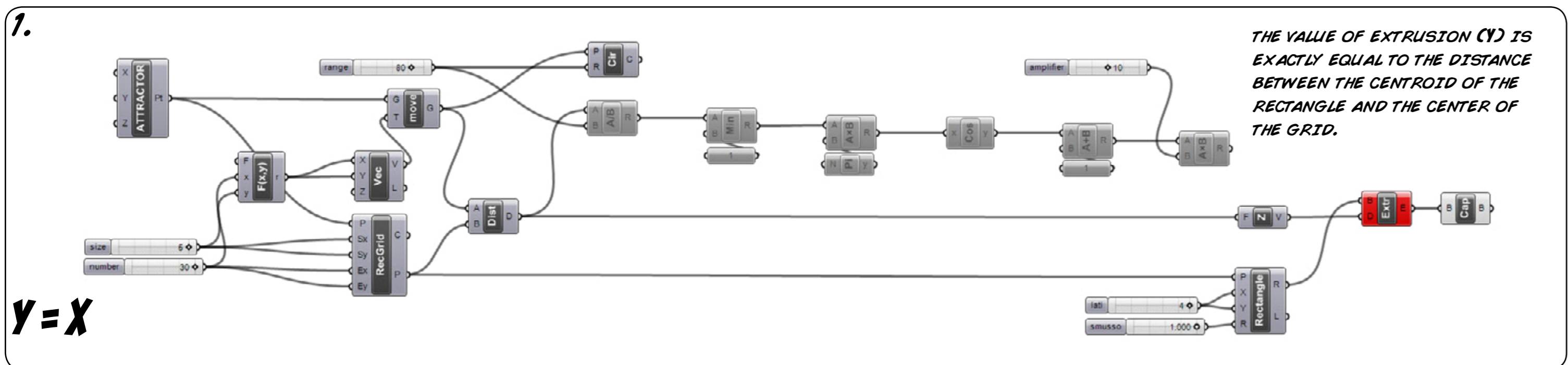

$Y = X$

$Y = BX$

$Y = BX (MAX1)$

$Y = BX \pi$

$Y = COSBX \pi$

$Y = (COSBX \pi) + 1$

$Y = A [(COSBX \pi) + 1]$

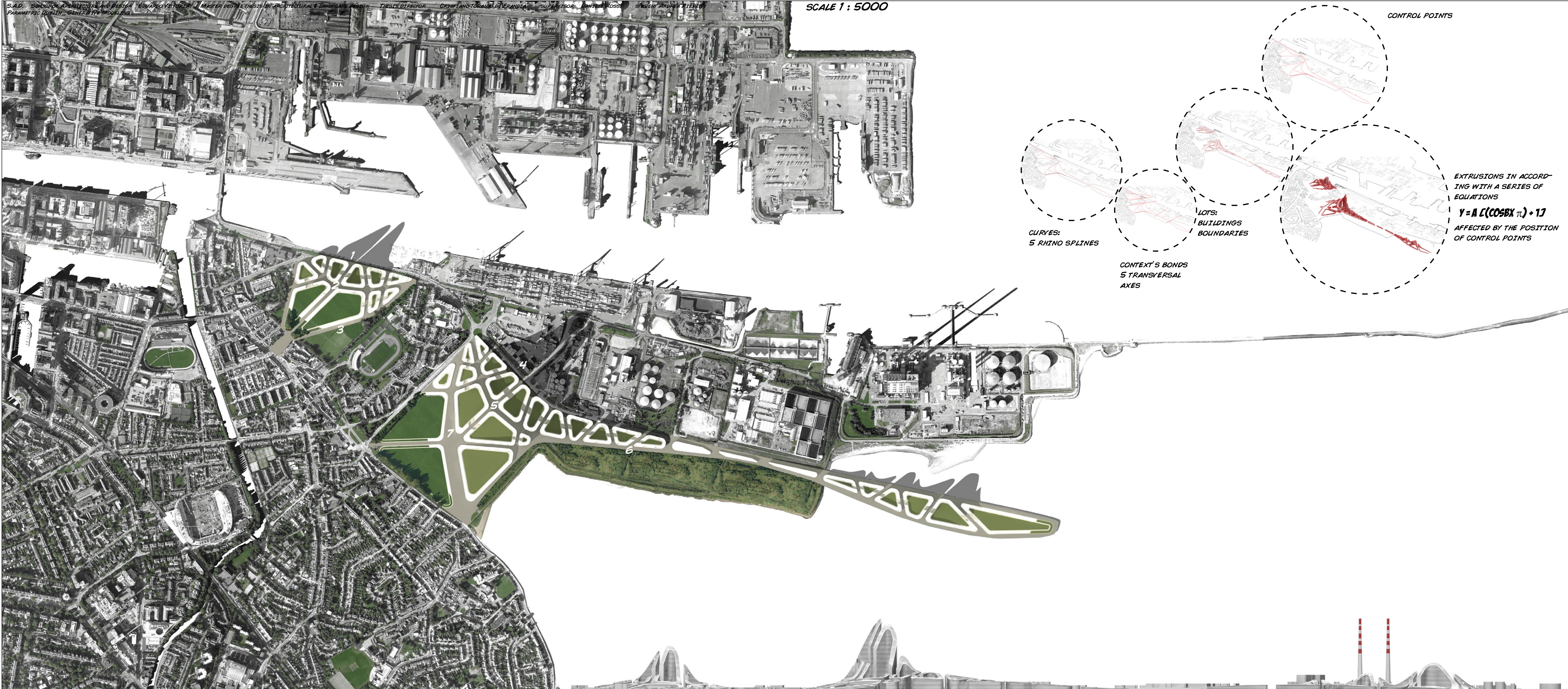

PUBLIC & PRIVATE TRANSPORTATIONS

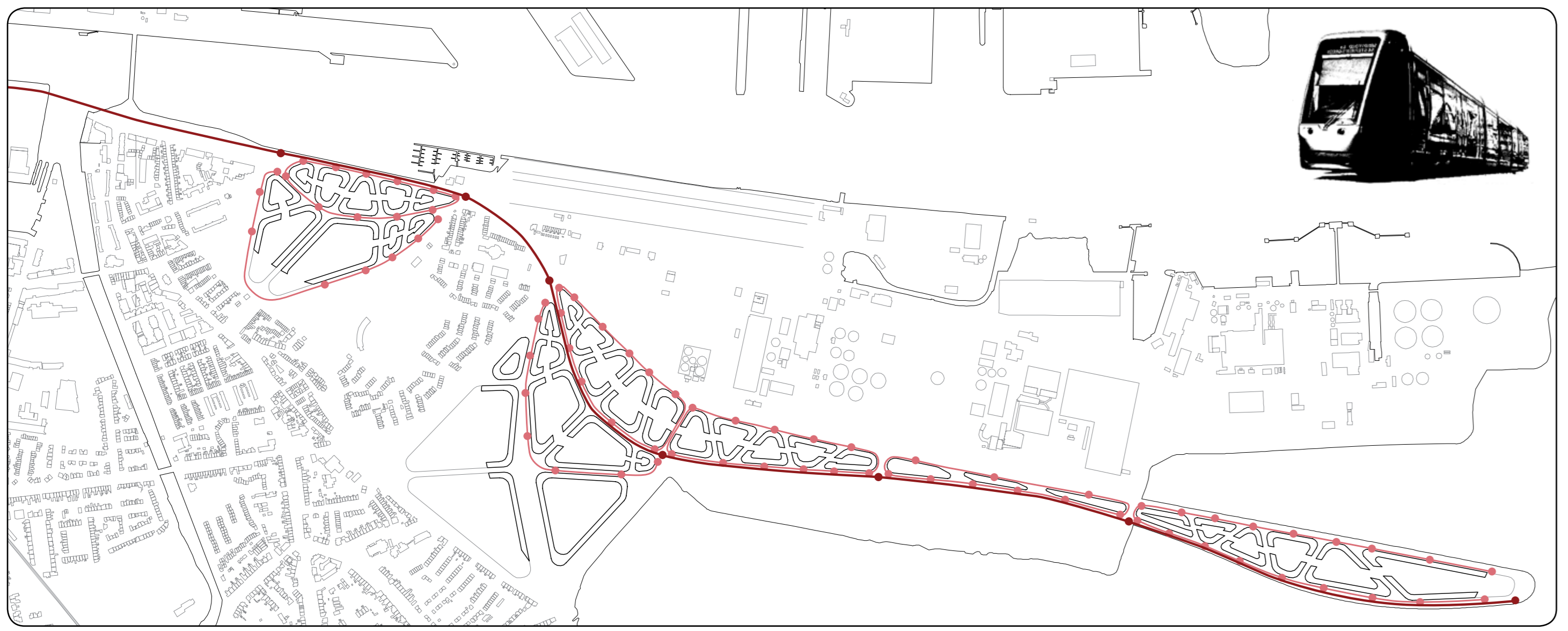

TRAM LUIAS + MINIMETRO

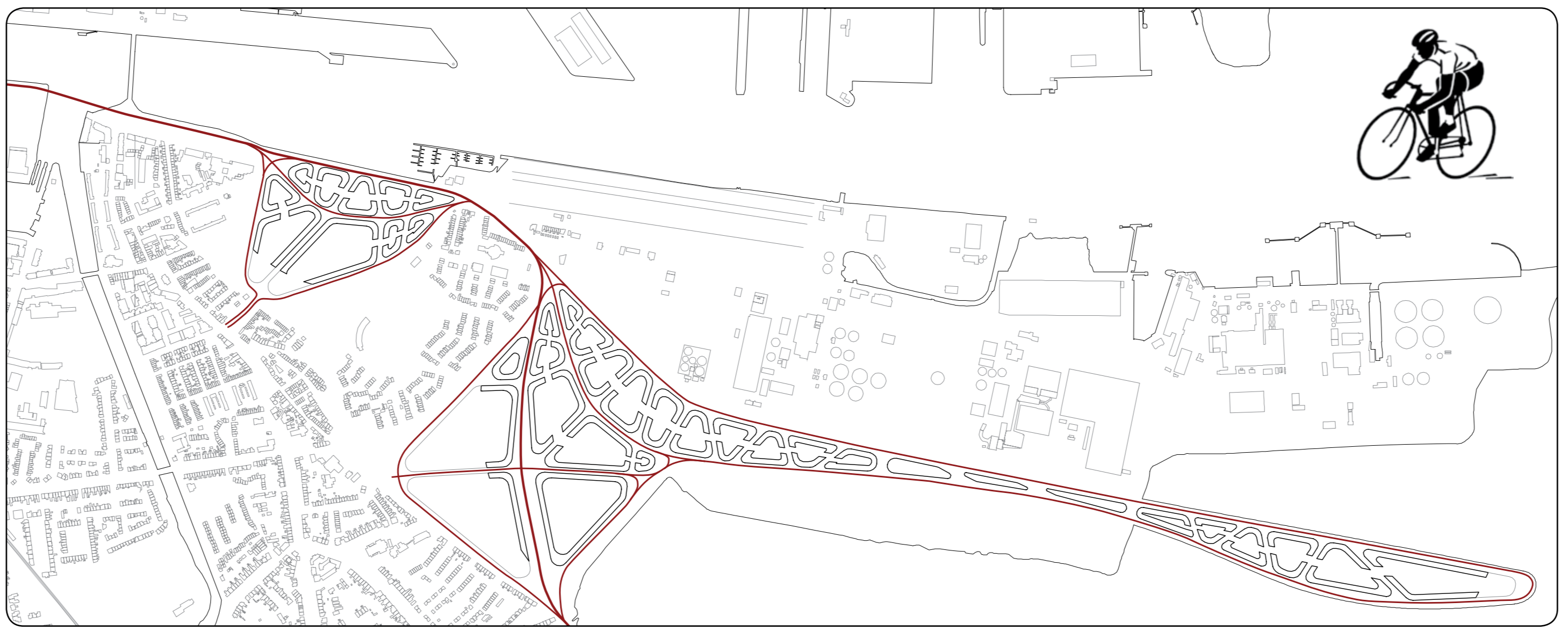

BIKE'S ROUTES

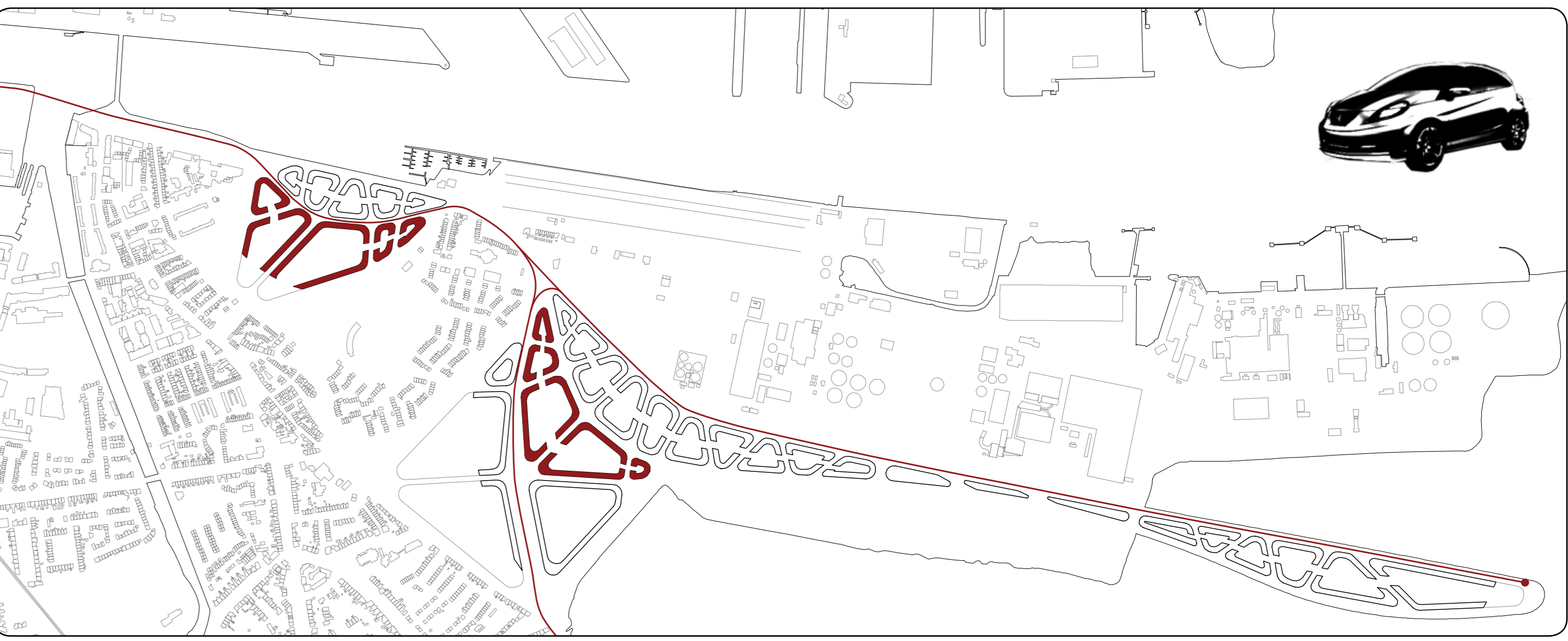

ROADS FOR CARS & PARKING

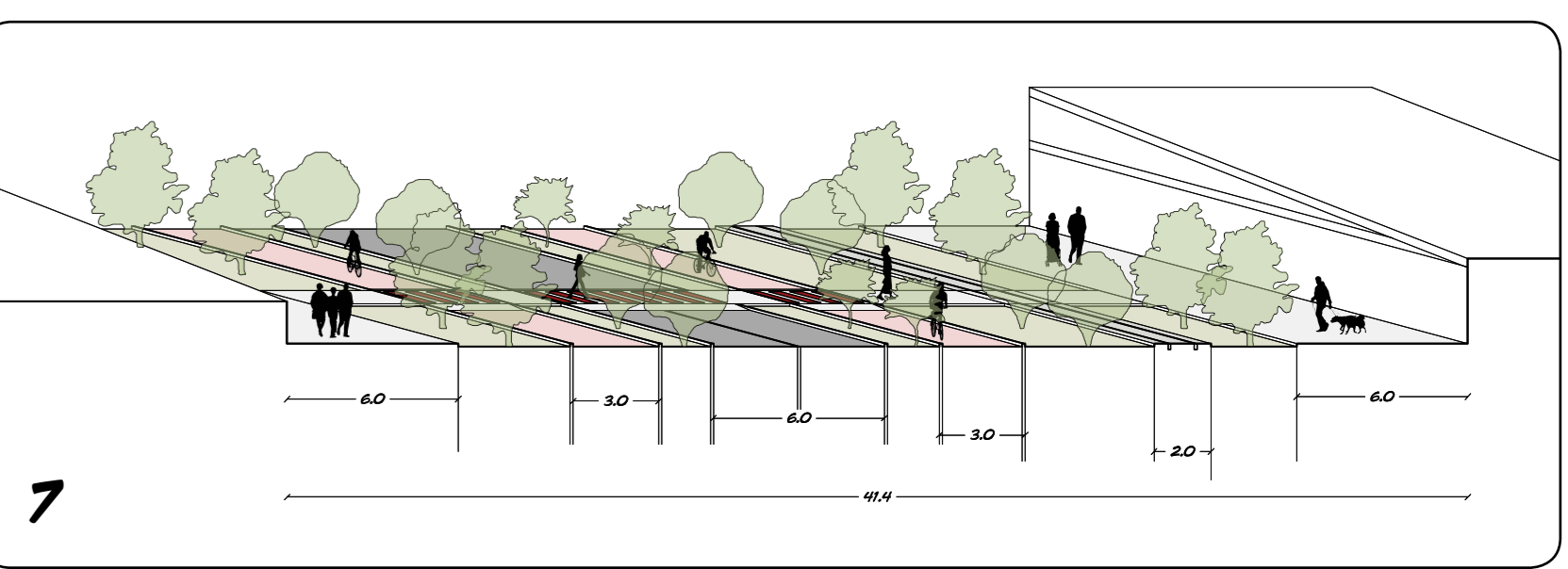
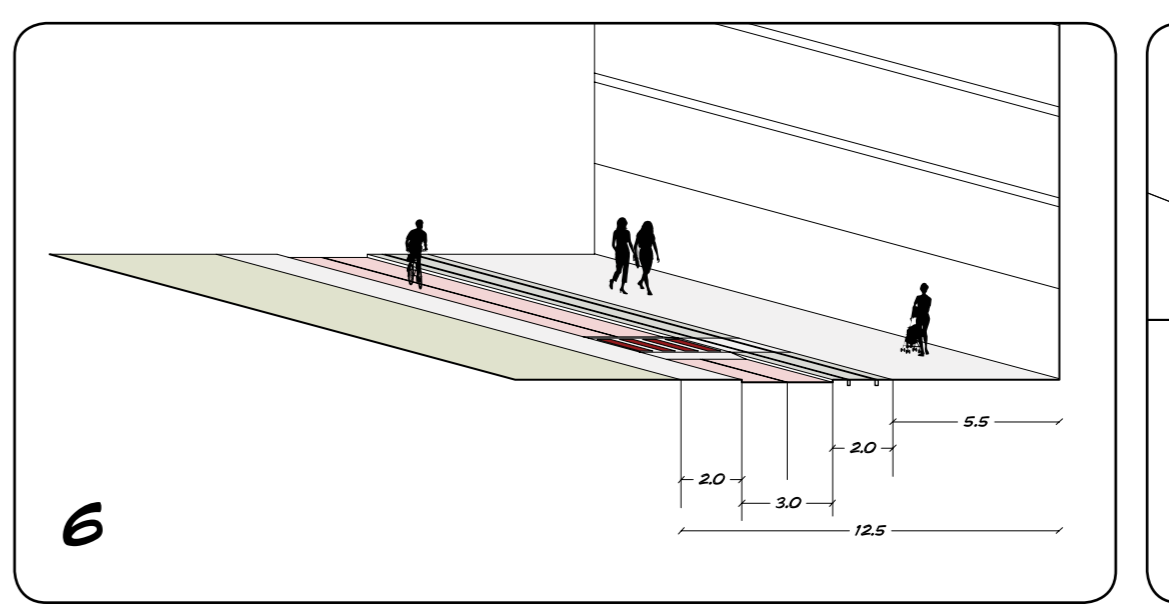
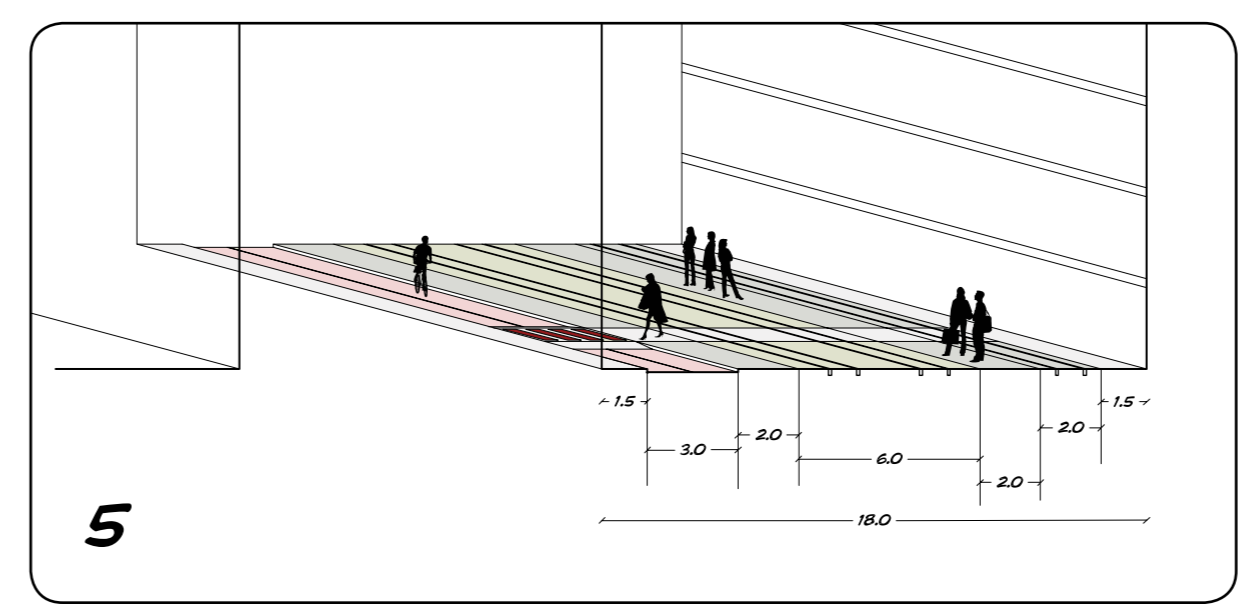
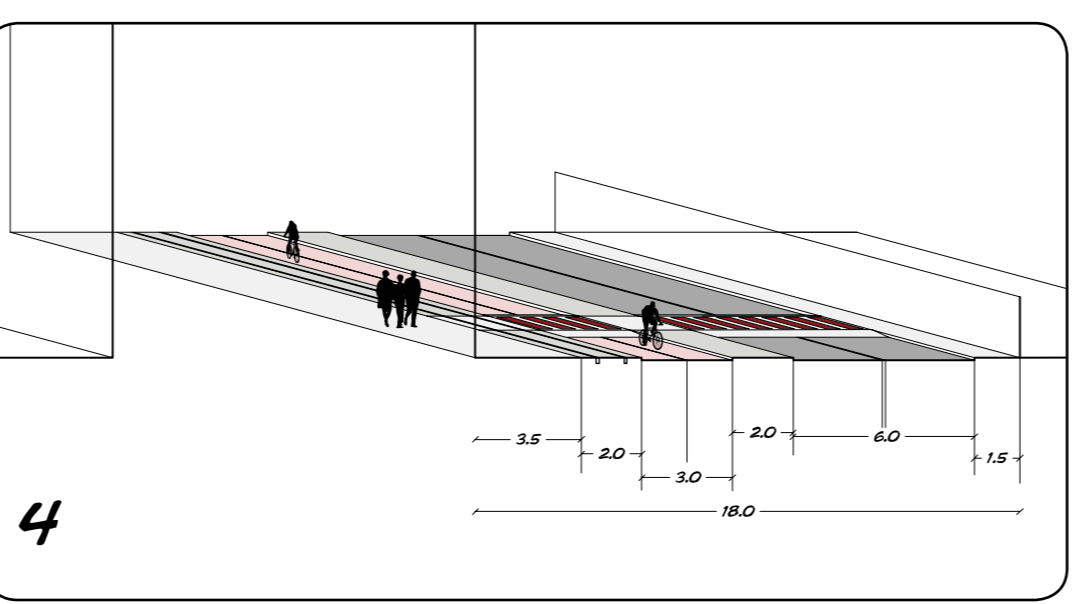
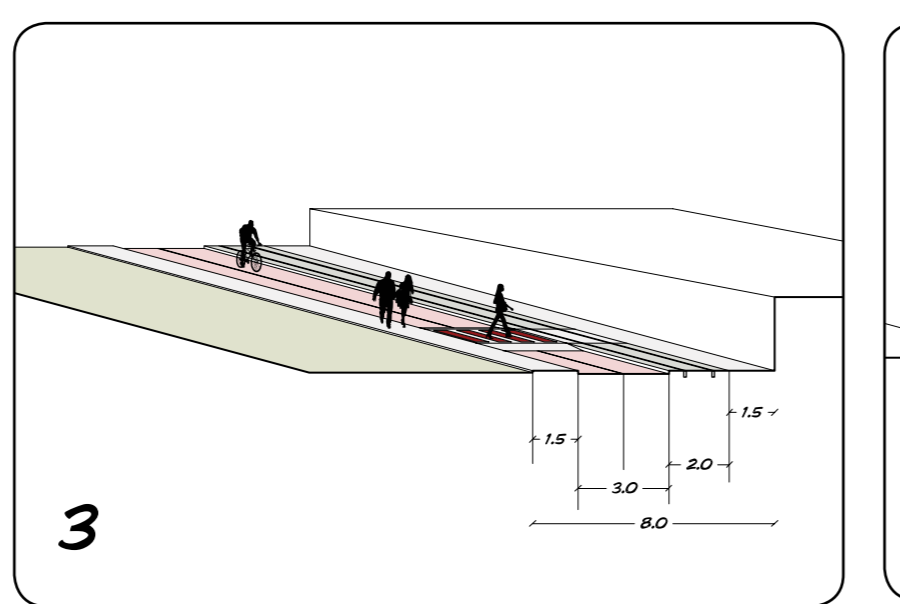
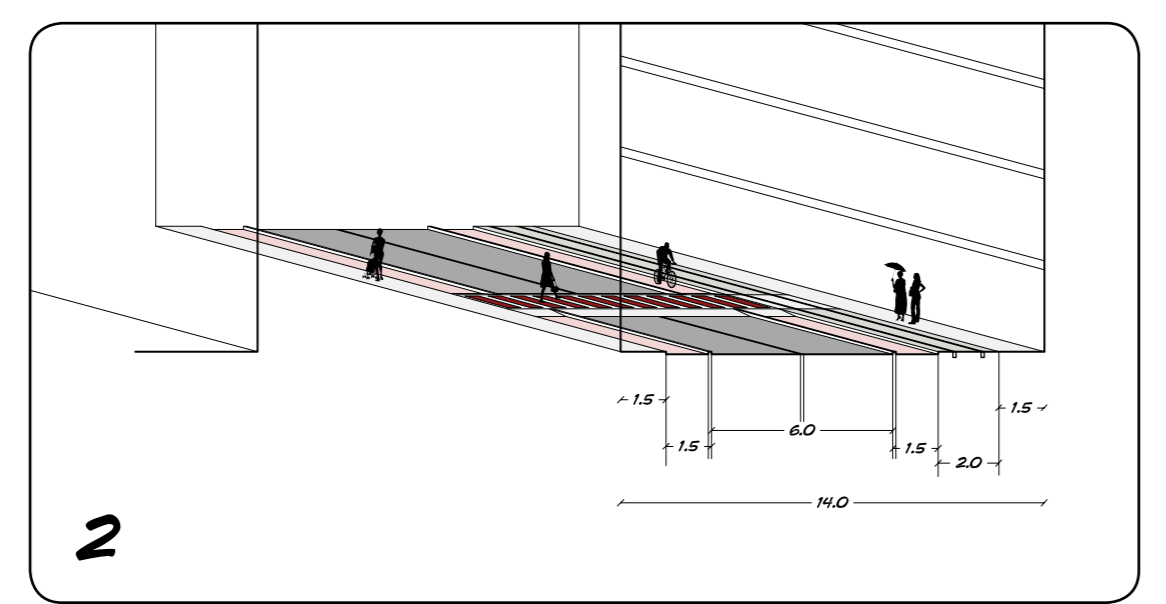
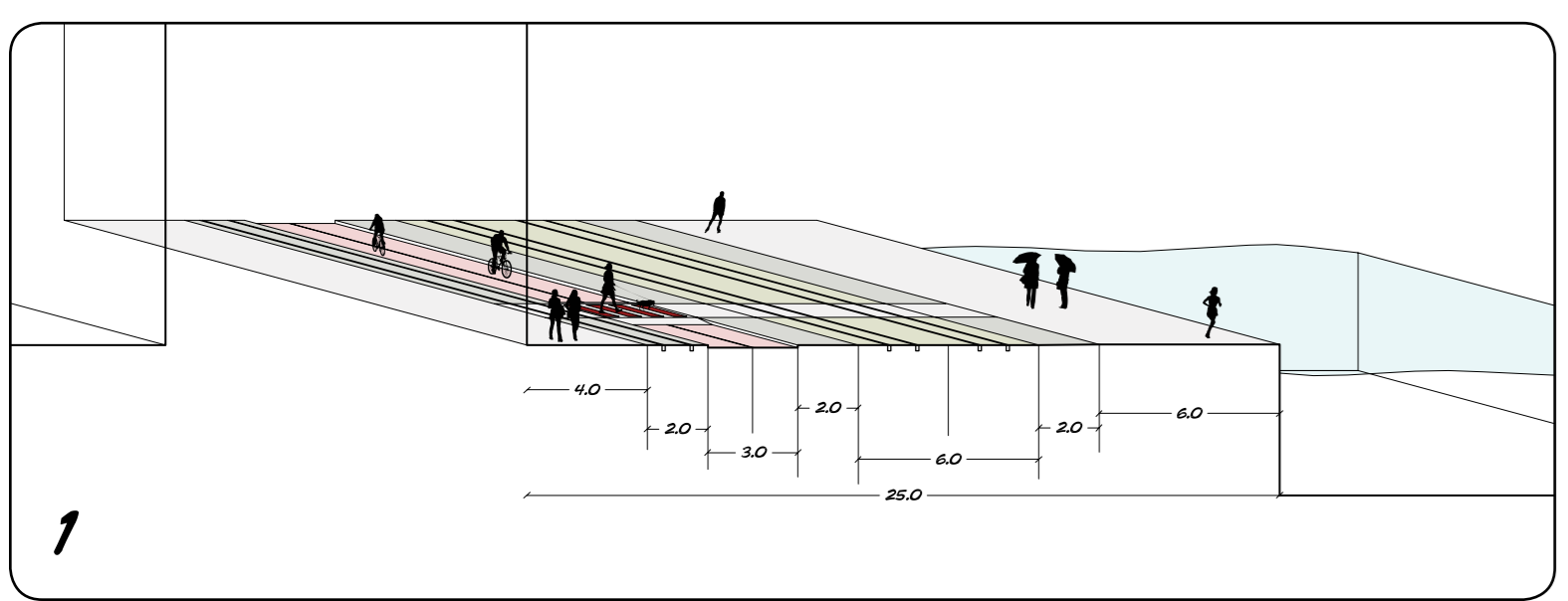





S.A.D. SCHOOL OF ARCHITECTURE AND DESIGN "EDUARDO VITTORIA" MASTER DEGREE THESIS IN ARCHITECTURAL & LANDSCAPE DESIGN THESIS DIRECTOR CRISTIANO TORALDO DI FRANCA SUPERVISOR DANIELE ROSSI STUDENT ANDREA PIERETTI
PARAMETRIC DUBLIN_GENERATIVE MODELING



